

**FRY**REGLET  
ARCHITECTURAL METALS

*The most recognized and specified brand of flashing in the nation.*

*Fry Reglet flashing and reglets conform to the  
current Miami-Dade Building Code*



## Why Fry Reglet?

Fry Reglet's comprehensive selection of moisture prevention products offer the ultimate in protection from the elements. Available nationwide in a variety of materials and finishes, Fry Reglet offers five pre-engineered flashing systems tailored for specific substrates — all designed, tested and proven to keep wind and moisture from getting under the roof. Plus, Fry Reglet provides a complete solution with drawings, installation instructions and the best technical support in the industry.

### SPRINGLOK™ FLASHING SYSTEM

Fry Reglet's SpringLok™ Flashing System offers architects, contractors and owners much more than ordinary field-fabricated components.

SpringLok is a pre-engineered system of flashing and reglets designed to secure the roof and prevent uplift in high winds.

Introduced more than 50 years ago, The SpringLok Flashing System has proven superior to other roof flashing systems and field flashing. Most roof failures begin at the perimeter and spread inward. The SpringLok Flashing System uses the relationship between our pre-engineered reglet and flashing to create resistance, or "spring" to hold the flashing tight against the parapet wall. In fact, each of our five reglets have been tested in accordance with ASTM D3161–Wind Resistance and, regardless of base metal, withstood sustained air velocity of 110 mph for two hours without evidence of uplift.

Fry Reglet SpringLok Flashing System is pre-engineered and roll-formed to precise specifications to provide superior results that can not be duplicated or replicated by brake-formed flashing.



*\* Specifier Note: Check your local code requirements for the suitability of .025" aluminum reglets and flashing in your area.*

# Save Time and Labor

Bending flashing on the job involves time, skill and most importantly, liability. Save yourself the hassle and the headaches with pre-engineered Fry Reglet flashings and reglets for virtually any substrate. Our reglets and flashing are roll-formed to precise factory standards unmatched by field brake-form presses. So while you're saving all that time and labor, you'll be saving money too.

## FEATURES

- Flashing snaps in under the reglet so water can't get under the flashing.
- A 1" end lap on the reglet and a 3" end lap on the flashing allows for proper alignment and eliminates leaky butt joints to ensure a watertight seal.
- Flashing has a positive air break to prevent water from climbing under the flashing.
- SpringLok flashing systems have been tested and proven to resist sustained wind velocities up to 110 mph for two hours.

## EASY TO INSTALL & USE

- Lightweight material is manufactured in 10' lengths for easy handling and installation on the job site.
- Precision, factory produced parts ensure a perfect fit on the job.
- Order factory fabricated reglet and flashing corners and eliminate time-consuming site fabrication.
- SpringLok flashing snaps into reglets without screws or clips, which means you can detach and reuse it when you need to reroof.

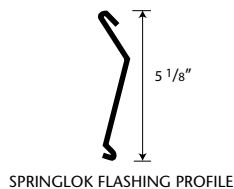

## "CO" CONCRETE REGLET

### USAGE

For use with poured-in-place concrete construction, this reglet is covered with a protective foam backer rod to prevent grout and concrete from getting into the reglet opening.

Connector clips are supplied to provide positive alignment at joints and prevent concrete leakage during pouring. Special staples are supplied to aid installation.

This system is not recommended for tilt-up construction; use SM surface mounted reglet instead.

### MATERIAL & THICKNESS

- Galvanized steel - 26 ga.
- Copper - 16 oz.
- Aluminum - 0.025" & **0.040"**\*
- Stainless steel, Type 304 - 0.020"

### FINISH & COLOR

- Galvanized steel - Standard zinc finish
- Copper - Standard uncoated finish
- Aluminum - Gray polyester coating
- Stainless steel, Type 304 - Standard uncoated finish

**\* Meets Dade County, Florida code**

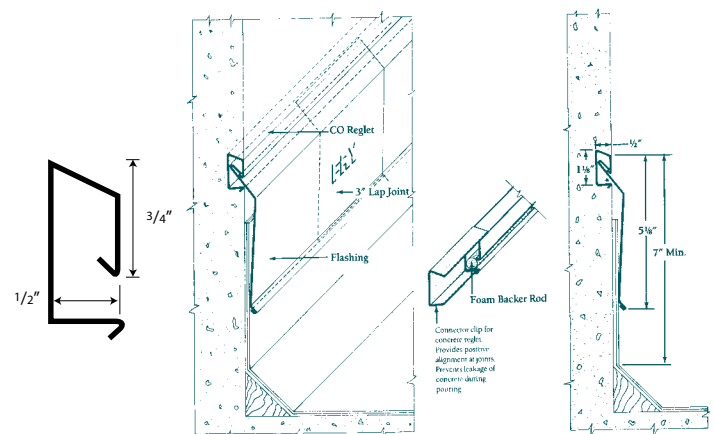

# Failure is Not an Option

Choose the roof flashing with a half century history of success in the field — *Fry Reglet, the most recognized and specified brand of flashing in the nation*. In over 50 years, our patented SpringLok Flashing System has never had a reported failure. And, it is the only flashing system to pass ASTM D3161— 2-hour, 110 mph wind load test.

## “MA” MASONRY REGLET

### USAGE

Specially manufactured for masonry applications, this reglet is laid into masonry joints and held in place as the mortar cures. As a result, there is no opening for water penetration.

Type MA reglet has a 1 1/2" top flange for brick; Type MA-4 has a 4" top flange for concrete block.

### MATERIAL & THICKNESS

- Galvanized steel - 24 ga.
- Copper - 16 oz.
- Aluminum - 0.025" & **0.040"**\*
- Stainless steel, Type 304 - 0.020"

### FINISH & COLOR

- Galvanized steel - Standard zinc finish
- Galvanized steel - Factory applied Kynar 500/Hylar 500 finish
- Copper - Standard uncoated finish
- Aluminum - Gray polyester coating
- Stainless steel, Type 304 - Standard uncoated finish

**\* Meets Dade County, Florida code**

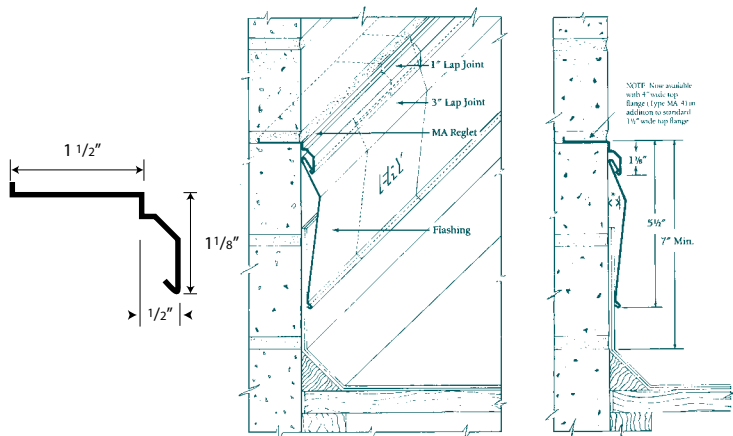

## “SM” SURFACE MOUNTED REGLET

### USAGE

SM reglet is designed for installation on any type of parapet wall, including tilt-up panels, precast panels, masonry and other smooth surfaces. Reglets are surface mounted with drive pins which are sealed with special washers (7/8" diameter stainless steel with neoprene facing).

Factory punched slots 16" o.c. allow for expansions and eliminate buckling away from the building.

System requires polyurethane, polysulfide or silicone sealant at time of installation in two places, at top and in recess, to seal against water penetration.

### MATERIAL & THICKNESS

- Galvanized steel— 24 ga.
- Copper —16 oz.
- Aluminum — 0.025" & **0.040"**\*
- Stainless steel, Type 304 — 0.020"

### FINISH & COLOR

- Galvanized steel — Standard zinc finish
- Galvanized steel — Factory applied Kynar 500/Hylar 500 finish
- Copper — Standard uncoated finish
- Aluminum — Gray polyester coating
- Stainless steel, Type 304 — Standard uncoated finish

**\* Meets Dade County, Florida code**

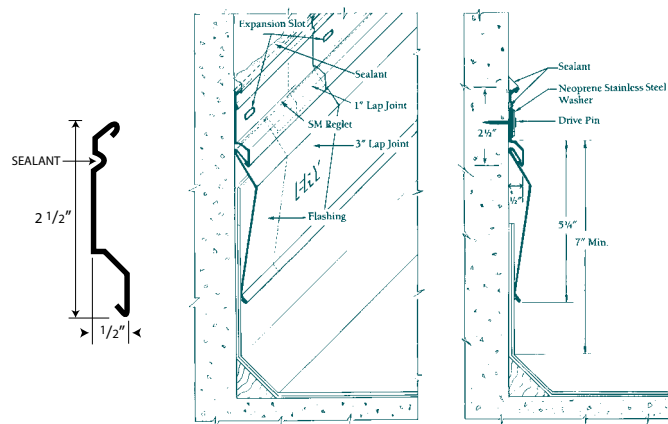

# Choose Fry Reglet

Fry Reglet offers five different reglets in a variety of metal substrates. Each reglet is engineered to work in conjunction with Fry Reglet flashing to provide the best solution for your application.

Fry Reglet also offers precoated flashings and reglets in factory-applied Kynar 500/Hylar 5000 finishes, providing years of worry-free performance, and eliminating the need for field painting.

## "ST" STUCCO REGLET

### USAGE

Made especially for stucco applications, the reglet is put in place over 3/4" baseboard prior to lathing, and the SpringLok flashing is locked into place after the roofing paper is applied. Then stucco is applied over the top.

This system requires a backing (nailer) with sufficient depth to support the reglet and provide tension to create the proper fit.

### MATERIAL & THICKNESS

- Galvanized steel - 24 ga.
- Copper - 16 oz.
- Aluminum - 0.025" & **0.040"**\*
- Stainless steel, Type 304 - 0.020"

### FINISH & COLOR

- Galvanized steel - Standard zinc finish
- Galvanized steel - Factory applied Kynar 500/Hylar 500 finish
- Copper - Standard uncoated finish
- Aluminum - Gray polyester coating
- Stainless steel, Type 304 - Standard uncoated finish

**\* Meets Dade County, Florida code**

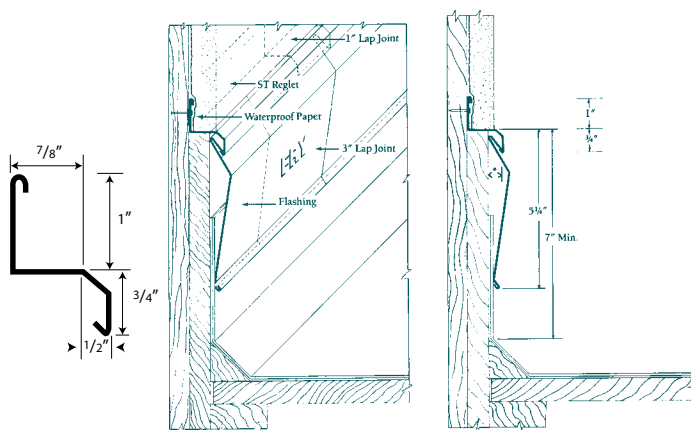

## "STX" STUCCO REGLET

### USAGE

STX reglet is specifically engineered for stucco over block conditions, and designed to accept SpringLok flashing and other flexible flashing. A "V" projection allows stucco to be applied directly over the reglet. The efficient design of the STX reglet eliminates the need for a backing (nailer).

### MATERIAL & THICKNESS

- Galvanized steel - 24 ga.
- Copper - 16 oz.
- Aluminum - 0.025" & **0.040"**\*
- Stainless steel, Type 304 - 0.020"

### FINISH & COLOR

- Galvanized steel - Standard zinc finish
- Galvanized steel - Factory applied Kynar 500/Hylar 500 finish
- Aluminum - Gray polyester coating
- Stainless steel, Type 304 - Standard uncoated finish

**\* Meets Dade County, Florida code**

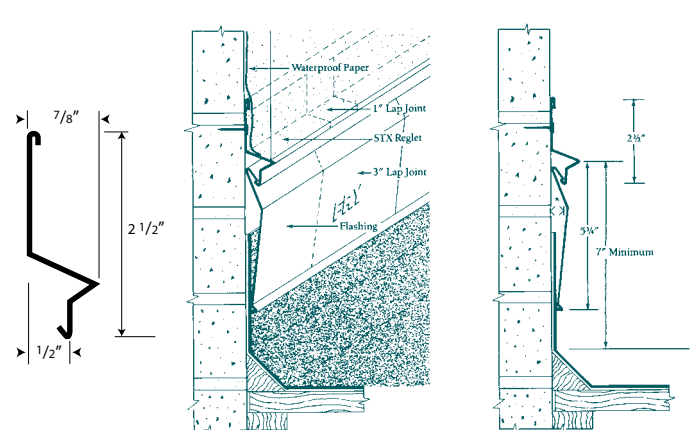

# Complete Thinking

Fry Reglet offers a total solution for commercial roof flashing applications. Our pre-engineered and pre-fabricated accessories and corners that make even the hardest part of the job that much easier — and with better results. Fry Reglet, complete solution and total support — always.

## ACCESSORIES

### PREFABRICATED REGLET CORNERS

#### APPLICATION

- Factory manufactured mitered and sealed corners help reduce installation time.
- Corners are available for reglet products shown as well as STX stucco.

#### INSTALLATION

- See separate sheets with individual reglet installation instructions.

### CONCRETE REGLET ACCESSORIES

#### CONNECTOR CLIPS

- Clips provide positive alignment at joints and prevent concrete leakage during pouring.

#### INSTALLATION STAPLES

- Staples secure reglet to forms prior to pouring concrete.

### VINYLOK FLASHING RETAINER

#### APPLICATION

- Polyvinyl chloride Vinylok flashing retainer fills many “too small” spaces between parapet and cant strip where standard flashings do not fit.
- For use with ST stucco, STX stucco, MA masonry and SM surface mounted reglet. Not for CO concrete.

#### INSTALLATION

- Flexible flashing is installed to contact reglet. Vinylok retainer is pressed into area with “tail” flat against flashing.

### COLOR REGLETS & FLASHING

- Fry Reglet Standard factory-applied Kynar 500/Hylar 5000 finishes: Bone and Bronze
- Special order pre-coated flashings and reglets in factory-applied Kynar 500/Hylar 5000 finishes. Call Fry Reglet for colors and delivery information.



SURFACE MOUNTED  
REGLET TYPICAL  
INSIDE CORNER

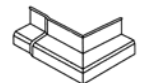

STUCCO REGLET  
TYPICAL INSIDE CORNER

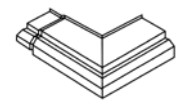

MASONRY REGLET TYPICAL  
OUTSIDE CORNER

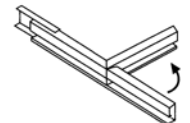

CONCRETE REGLET  
TYPICAL OUTSIDE CORNER

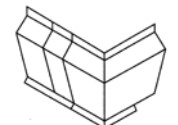

TYPICAL FLASHING  
OUTSIDE CORNER

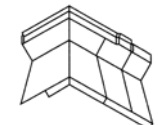

TYPICAL FLASHING  
INSIDE CORNER

#### Surface Mounted Reglet

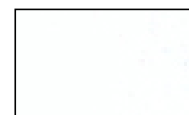
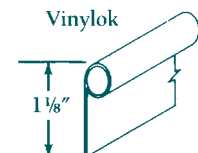
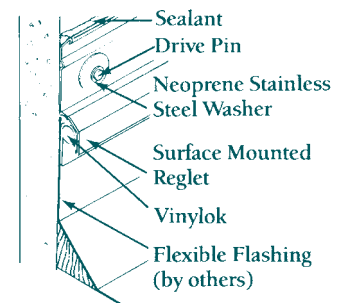

Bone

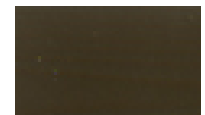

Medium Bronze

Contact Fry Reglet for product details, installation instructions and complete wind load test data. Drawings are not to scale.



Available Nationwide

800.237.9773 • Fax: 800.200.4379

[www.fryreglet.com](http://www.fryreglet.com)